

- 1
1x 1x

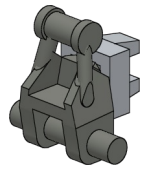

- 2
1x
1x

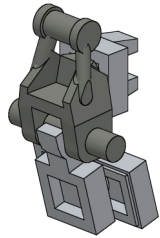

- 3
2x

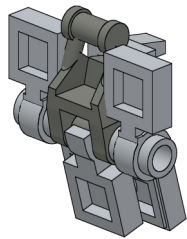

- 4
1x
1x
1x

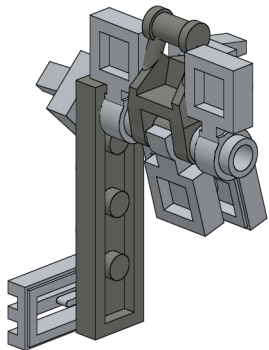

- 5
2x
1x
1x

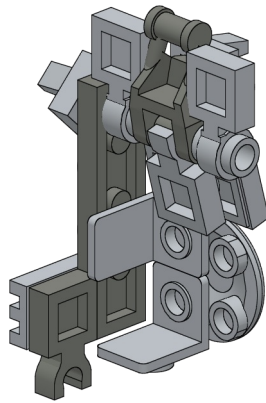

- 6
3x

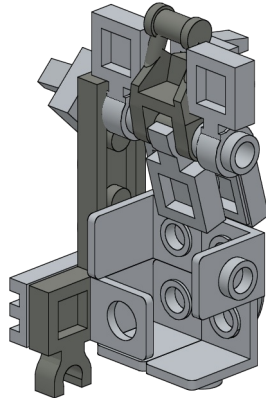

- 7
1x
1x

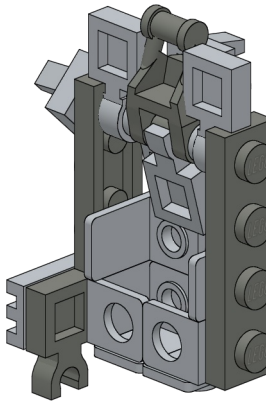

- 8
1x
1x
1x

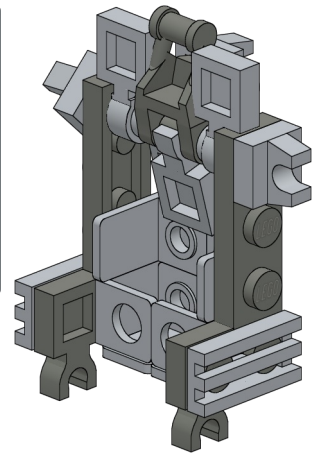

- 9
1x
1x

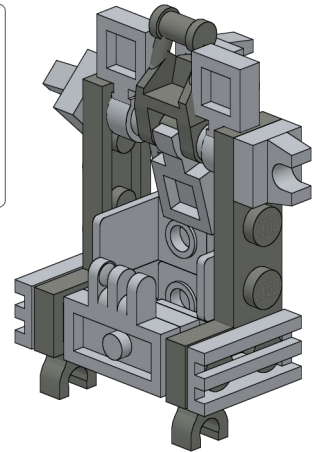

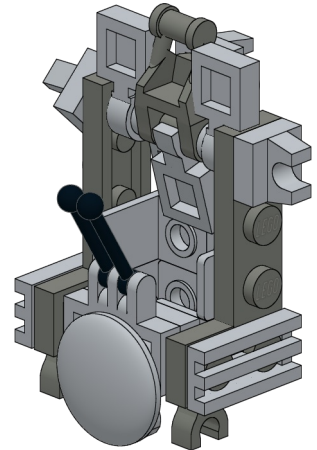

- 10
2x
1x

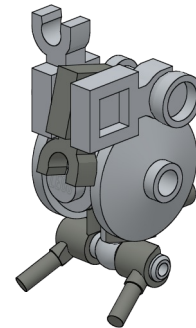
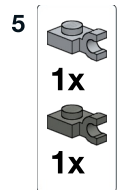
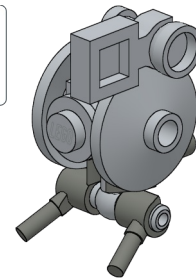
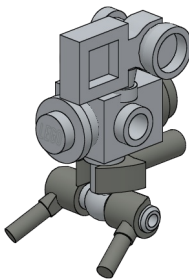
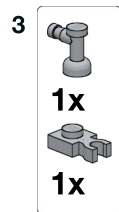
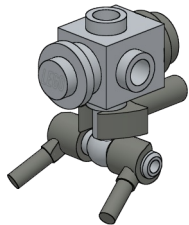
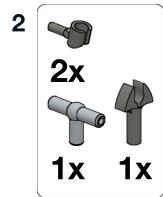
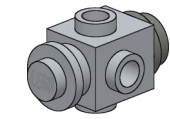
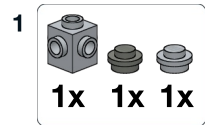

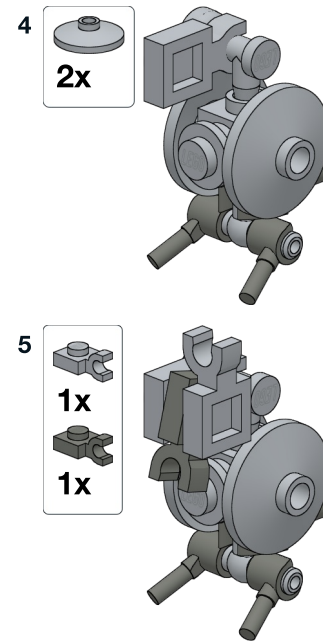
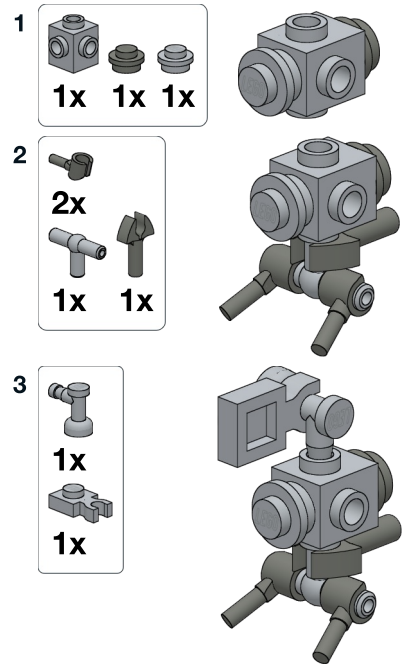





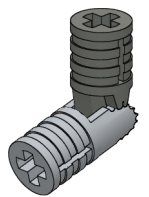



- 1
-  1x
 -  1x

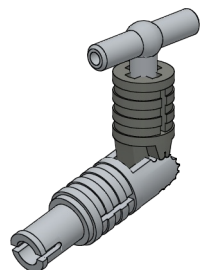

- 2
-  1x
 -  1x



- 3
-  1x
 -  1x
 -  1x

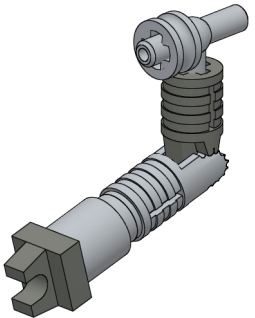

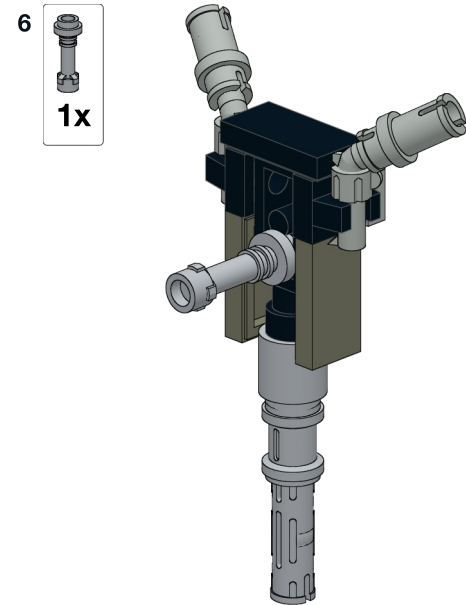
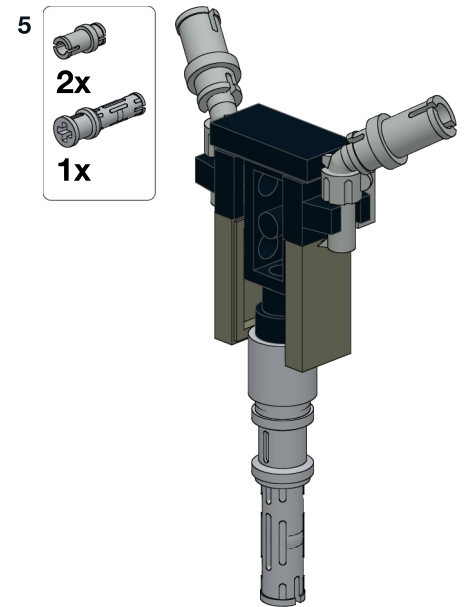
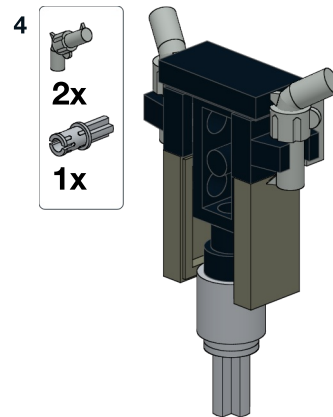
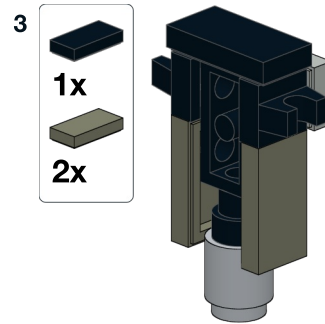
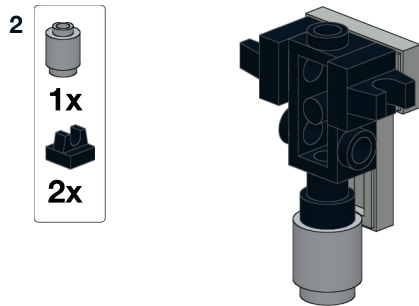
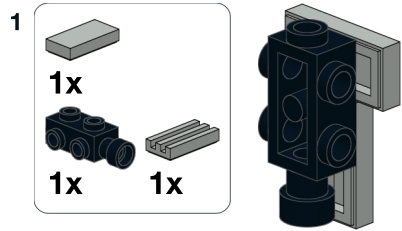

11

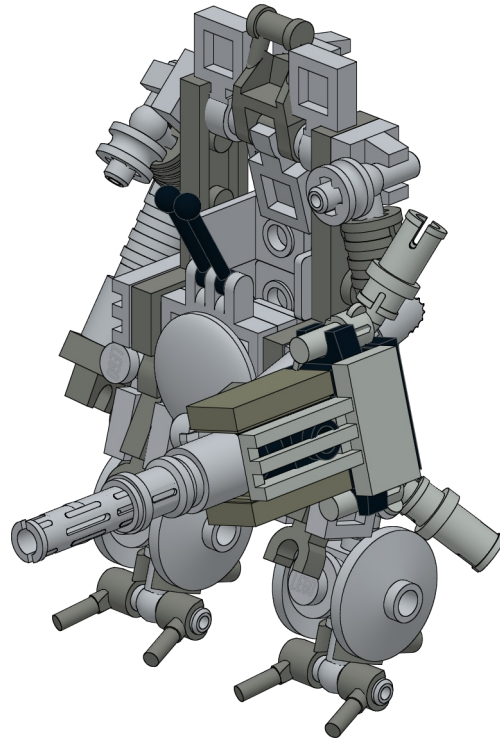
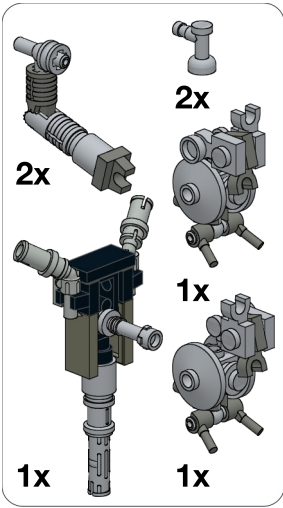

- 1
- 2x
 - 1x
 - 2x

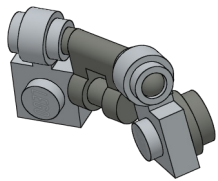

- 2
- 1x
 - 1x
 - 1x

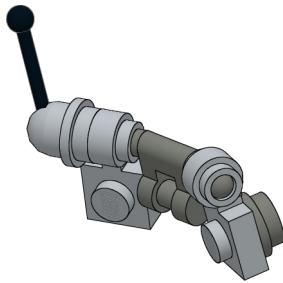

- 3
- 1x
 - 1x
 - 1x

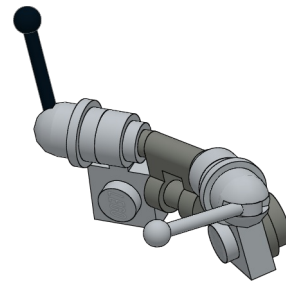

- 4
- 1x
 - 2x
 - 2x

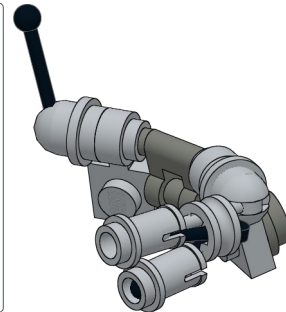

12

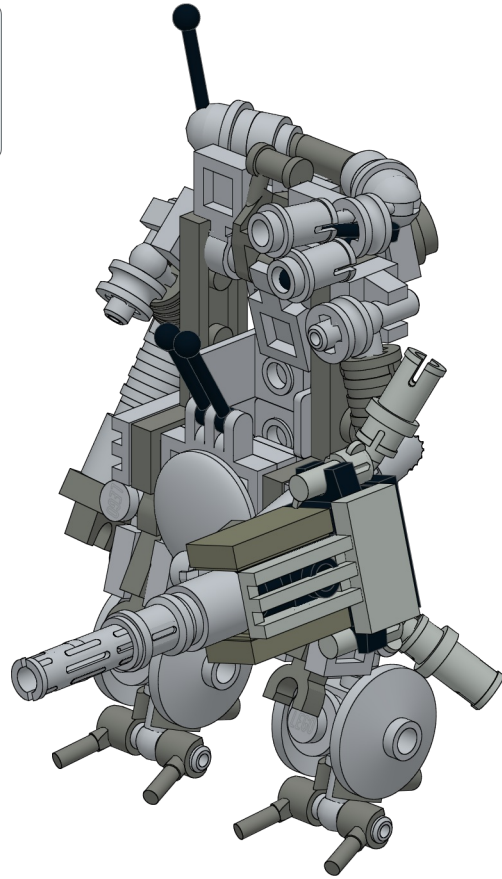
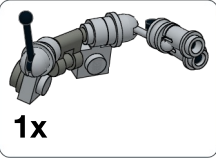

13

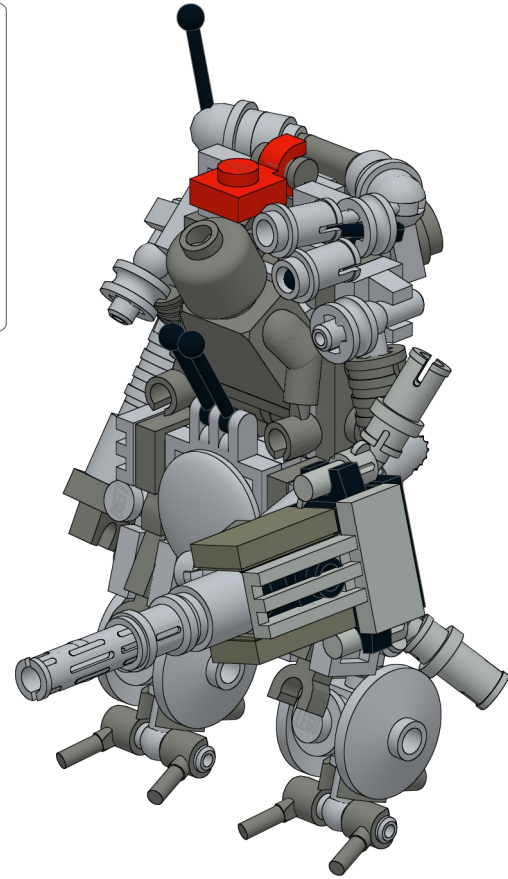
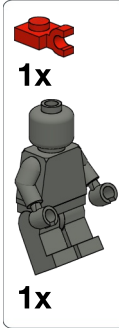

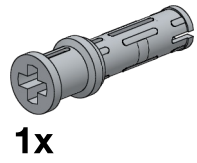

1x



2x

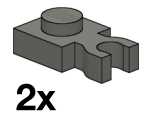

2x

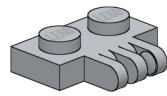

1x

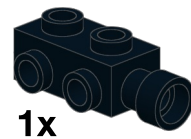

1x

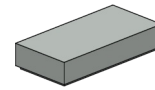

1x

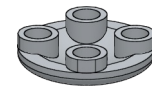

2x

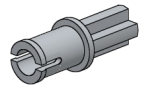

2x



4x

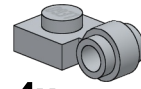

4x



4x



5x

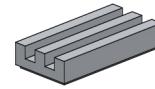

2x



2x



2x

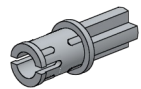

1x

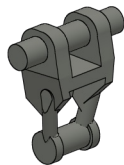

1x

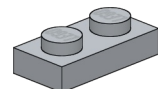

1x



4x



1x

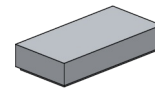

1x

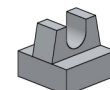

3x



4x

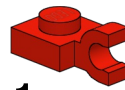

1x

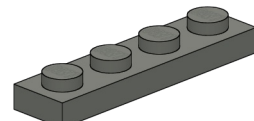

2x



2x

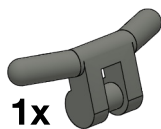

1x

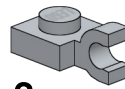

3x



2x

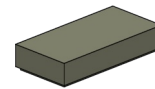

2x

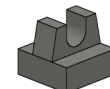

2x

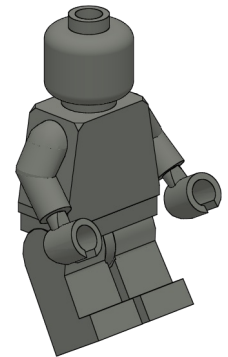

1x



1x



2x

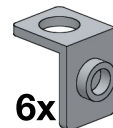

6x

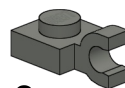

2x

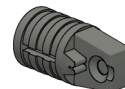

2x

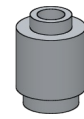

3x

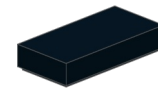

1x

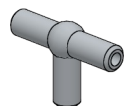

4x

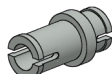

2x

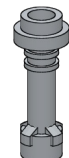

1x

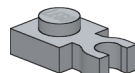

2x

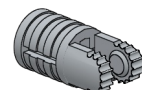

2x

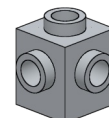

2x

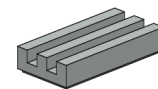

1x

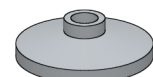

4x