

1

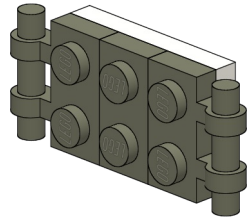

2

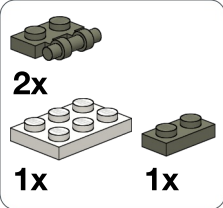
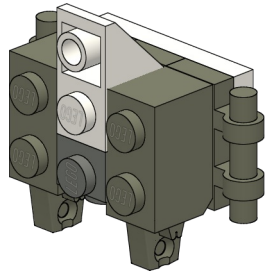
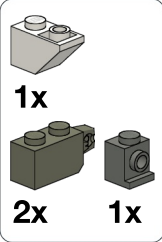

3

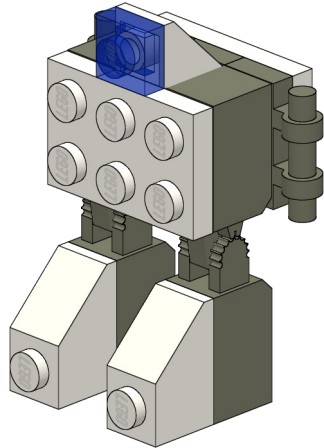
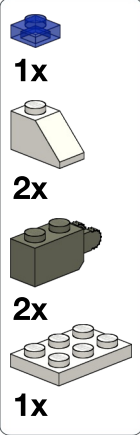

4

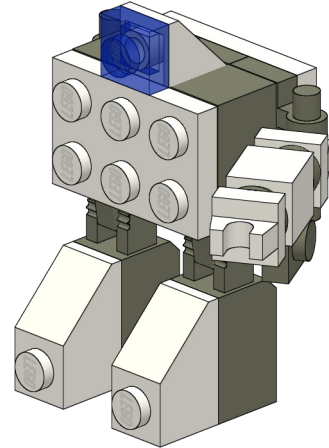
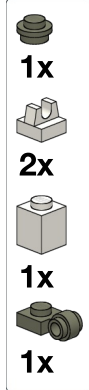

5

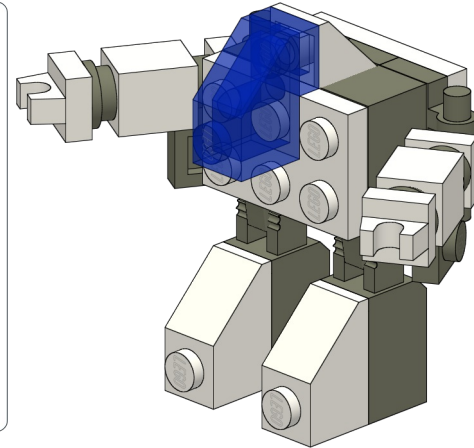
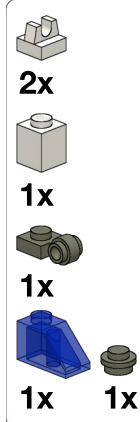

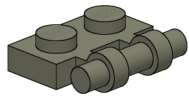

2x

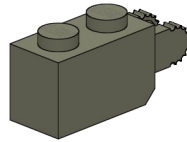

2x

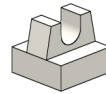

4x

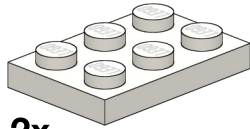

2x



2x

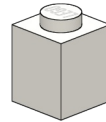

2x

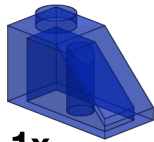

1x

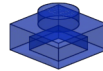

1x

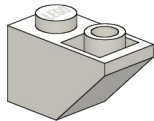

1x

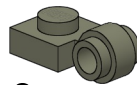

2x

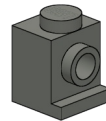

1x

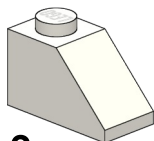

2x

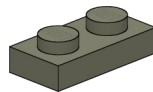

1x

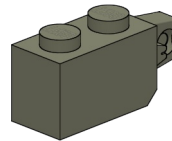

2x