

7

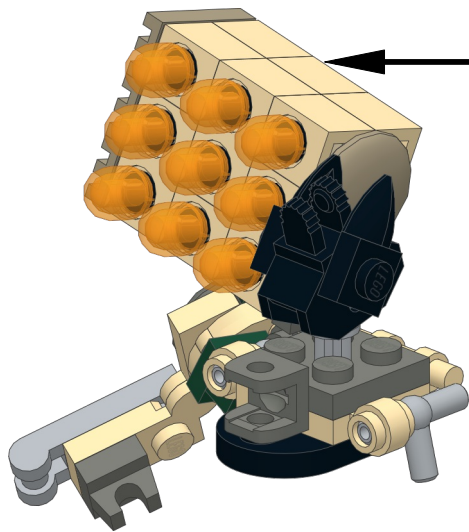

1

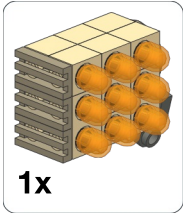
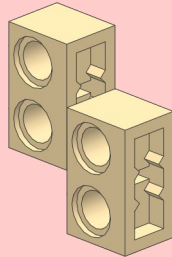
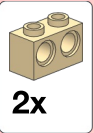

2

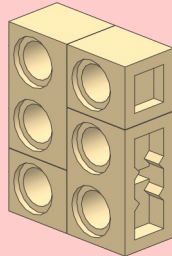

3

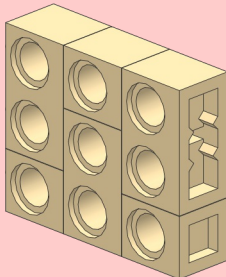
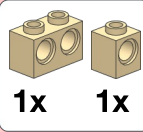

4

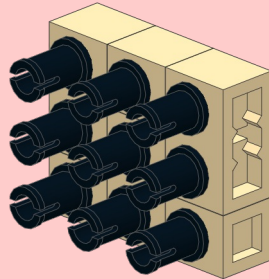

5

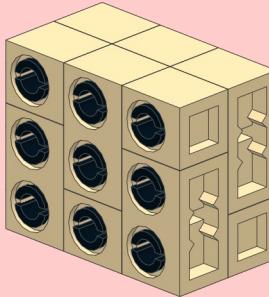
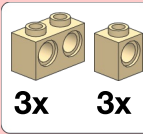

6

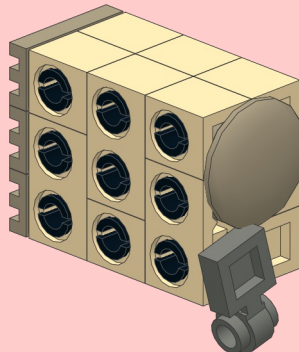
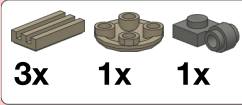

7

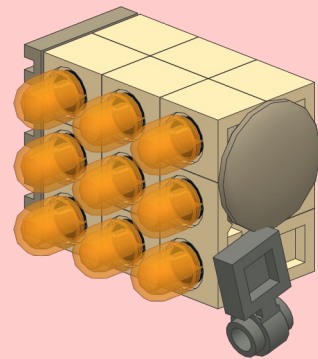

8

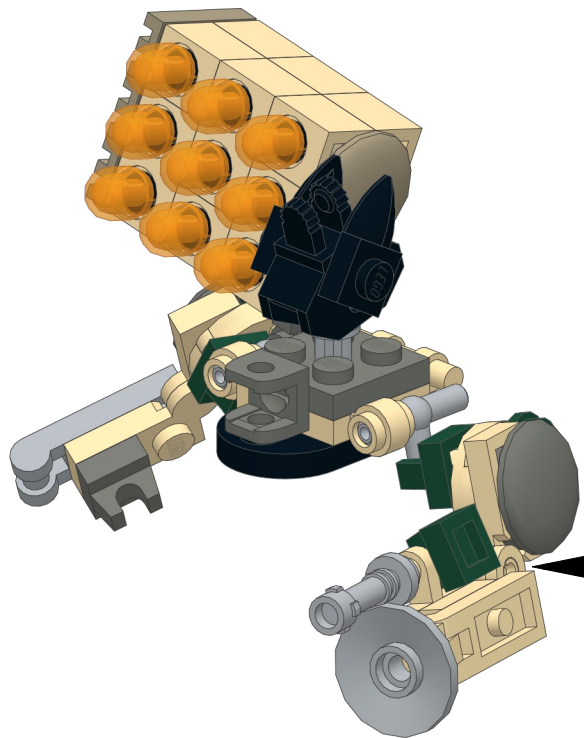
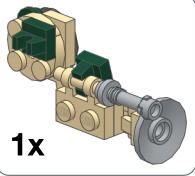

1

1x 1x

2

1x 1x
1x 1x

3

4

1x 1x

5

1x 1x 1x

9

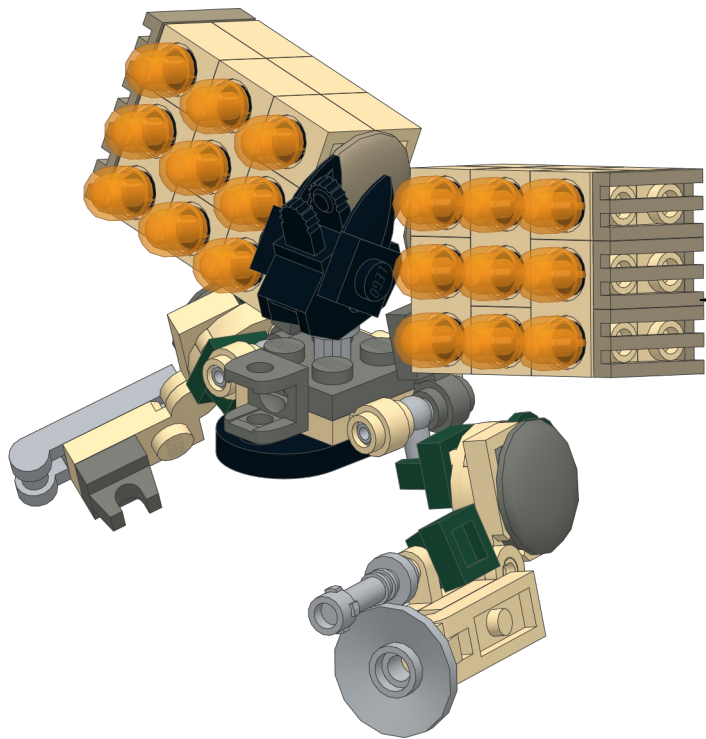
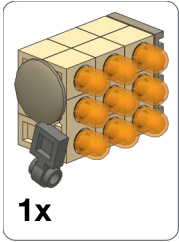

1

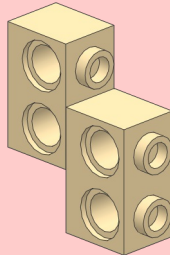
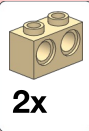

2

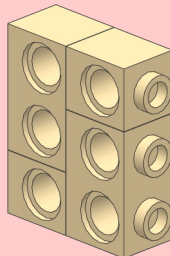

3

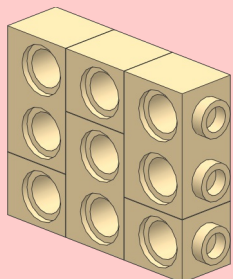
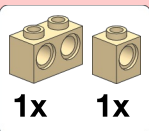

4

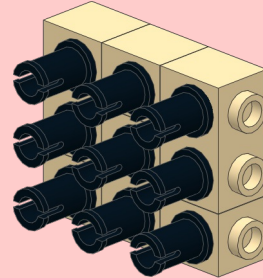

5

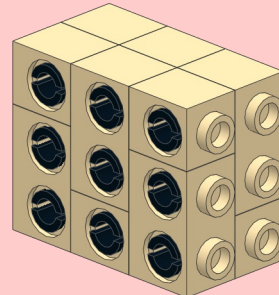
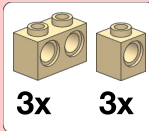

6

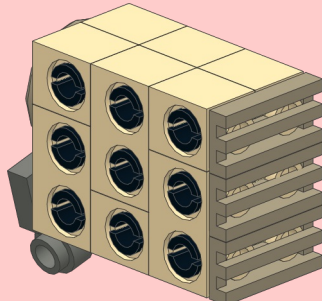
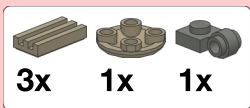

7

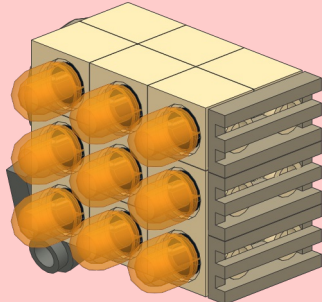

6

