

- 1  
1x 1x

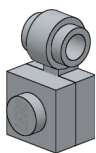

- 2  
2x

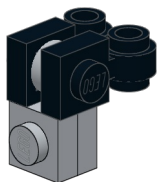

- 3  
2x

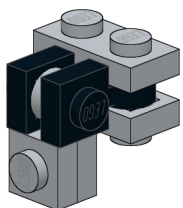

- 4  
2x  
1x

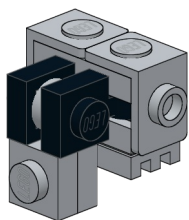

- 5  
2x  
1x

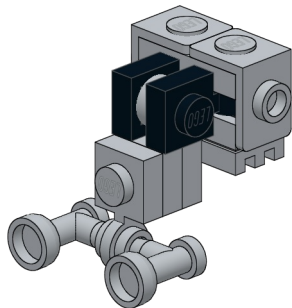

- 6  
2x  
1x  
1x

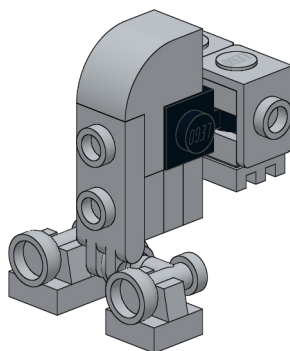

- 7  
2x  
2x

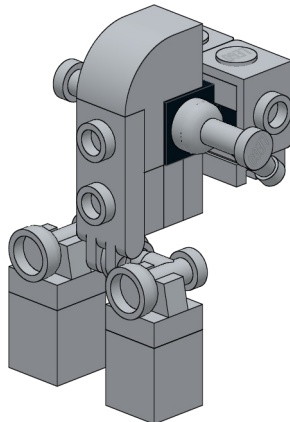

- 8  
2x  
2x

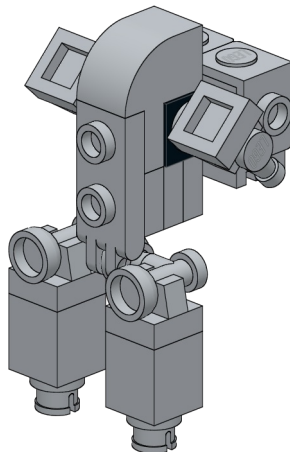

- 9  
2x  
2x  
2x

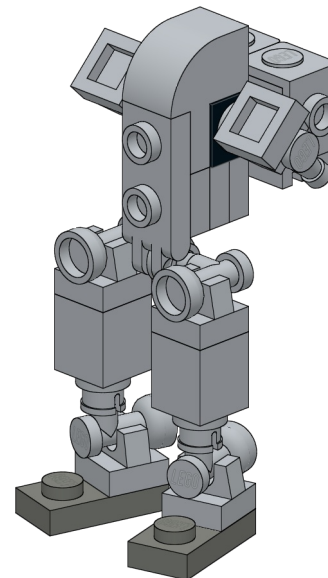

- 10  
2x  
2x  
4x  
2x

