

Metalstorm

Design

onosendai2600

Andrew Lee

All rights reserved

Used with permission

LDraw model

Wordman



L Pub instructions

Wordman

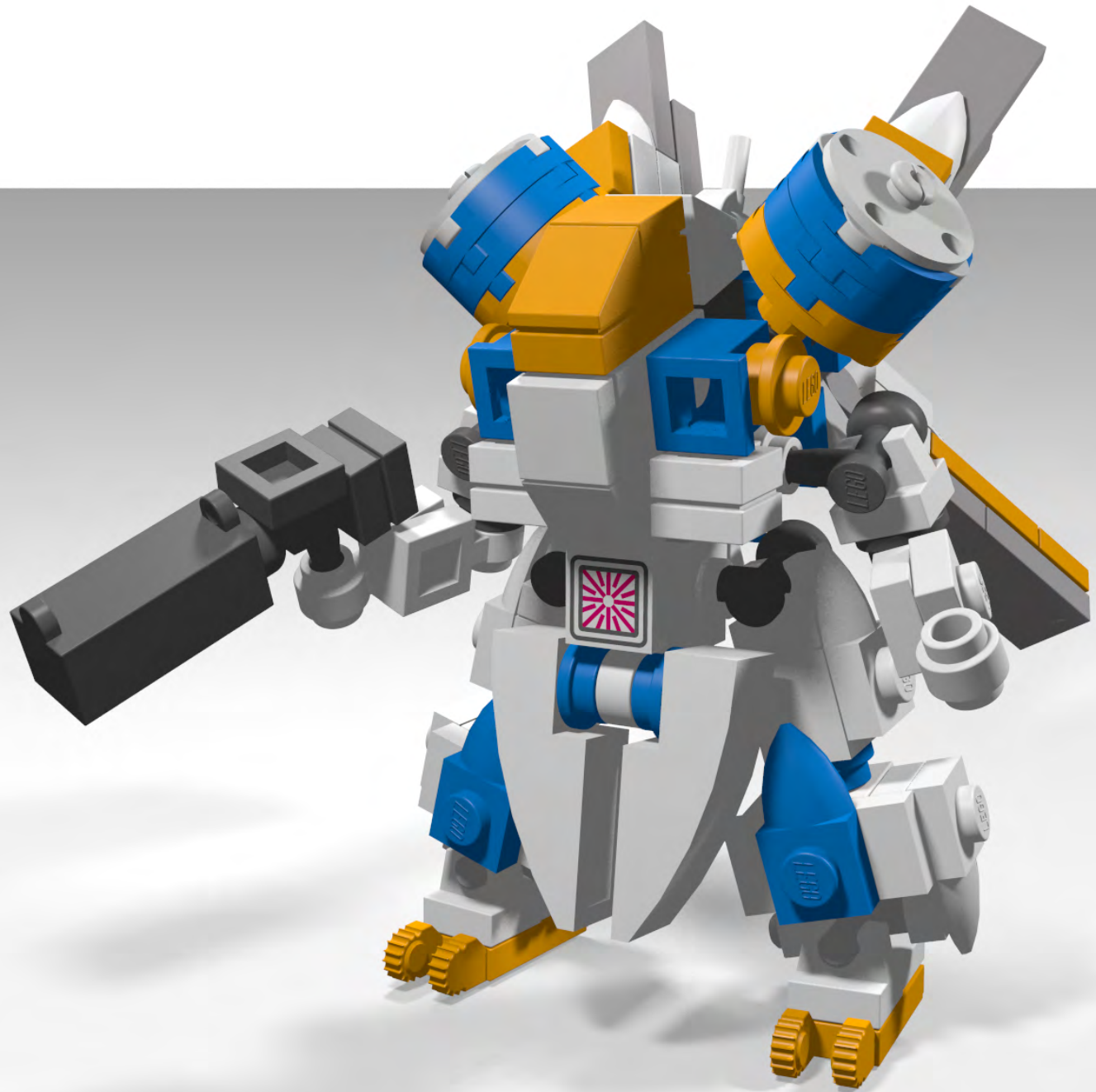

URLs

Source:



LDraw file:



This PDF:



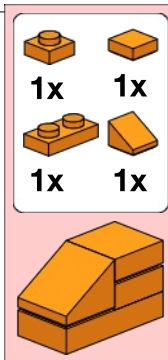
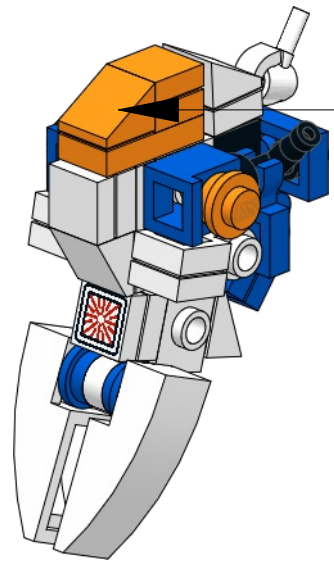
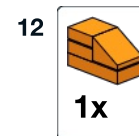
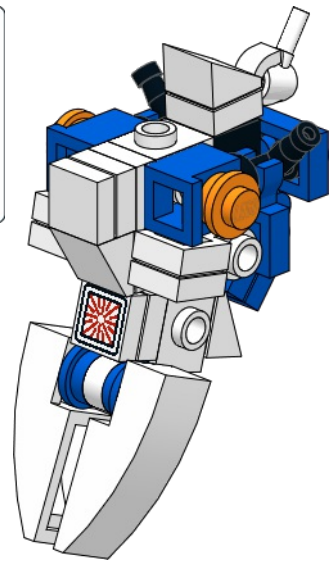
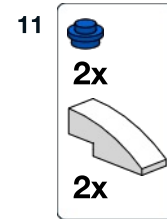
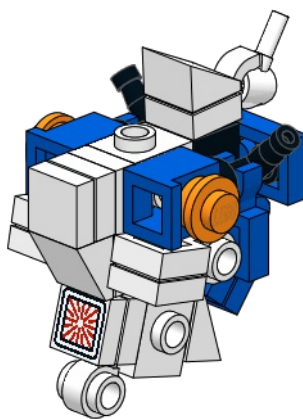
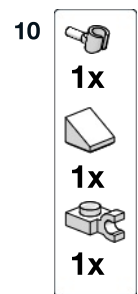
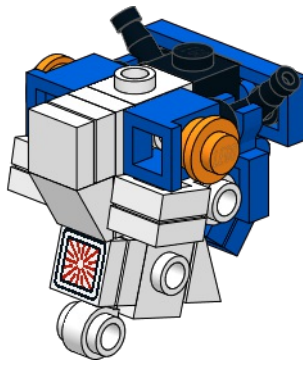
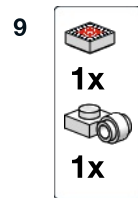
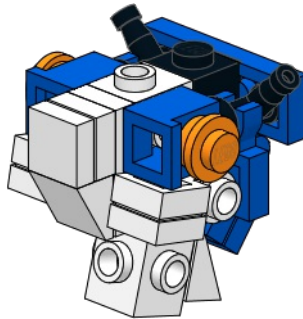
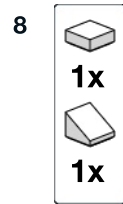
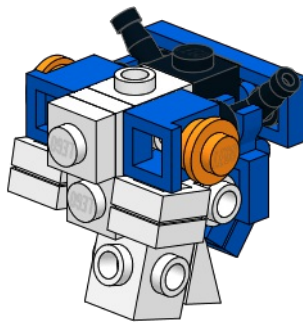
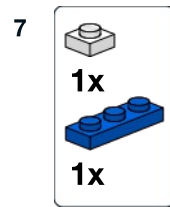
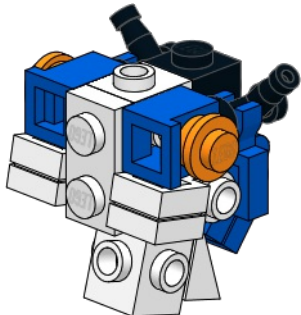
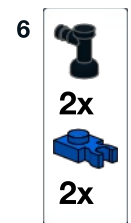
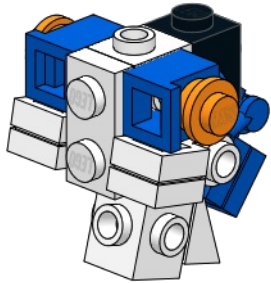
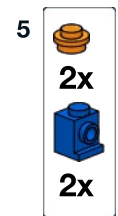
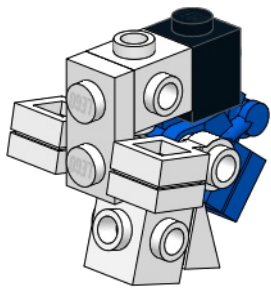
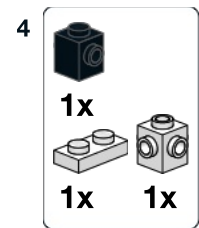
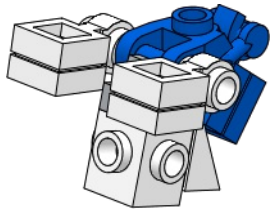
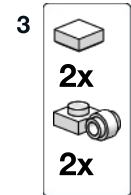
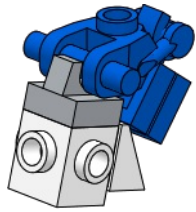
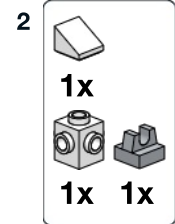
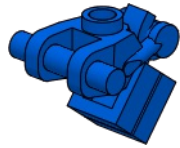
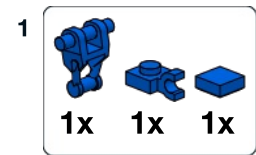

13

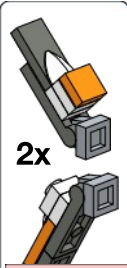

1

- 1x [white 1x1 brick]
- 1x [grey 1x3 brick]
- 1x [grey 1x1 brick]

2

- 1x [orange 1x1 brick]
- 1x [grey 1x1 brick]
- 1x [grey 1x1 brick]

x2

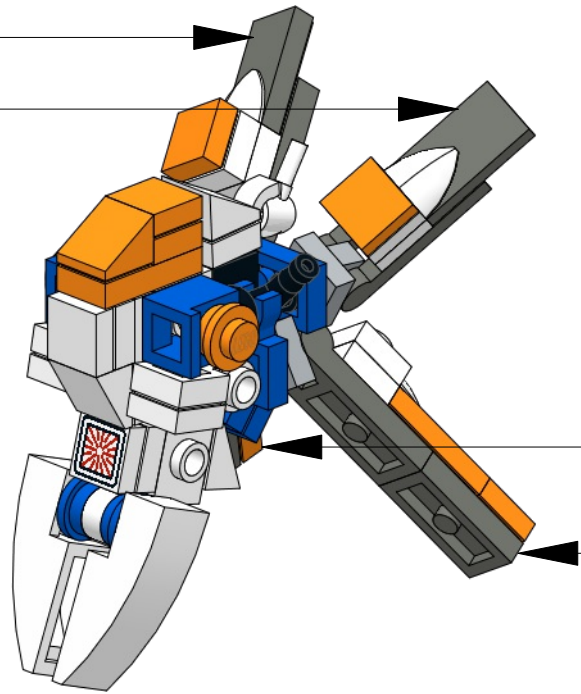

1

- 1x [grey 1x1 brick]
- 1x [grey 1x3 brick]

2

- 1x [orange 1x3 brick]
- 1x [white 1x1 brick]



3

- 1x [orange 1x1 brick]
- 1x [grey 1x1 brick]
- 1x [grey 1x1 brick]

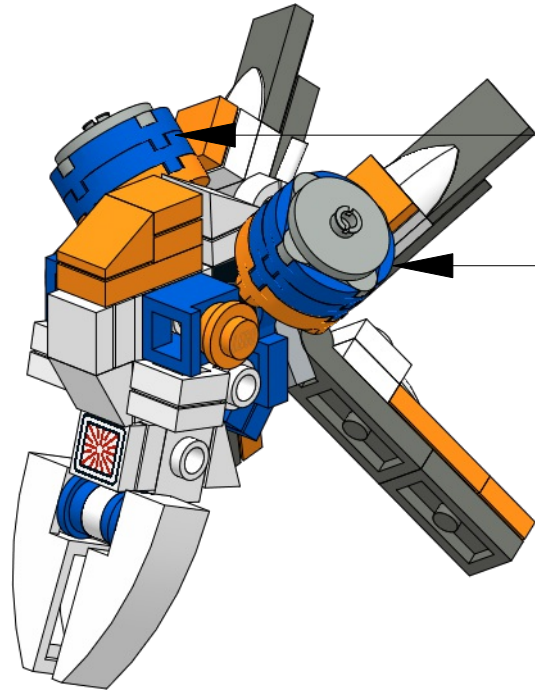

x2

14

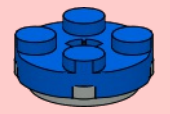

1  
1x 1x



2  
1x 1x

x2

