

12

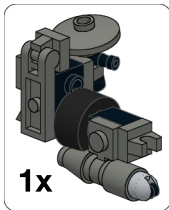

1

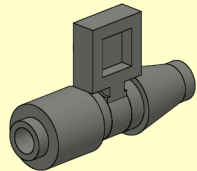

2

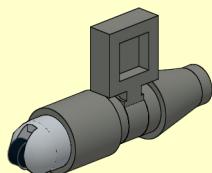
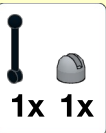

3

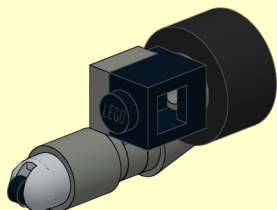

4

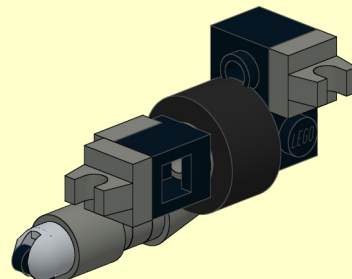
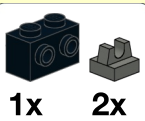

5

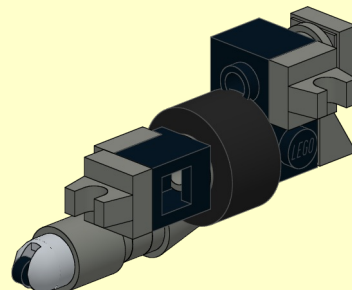
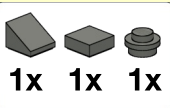

6

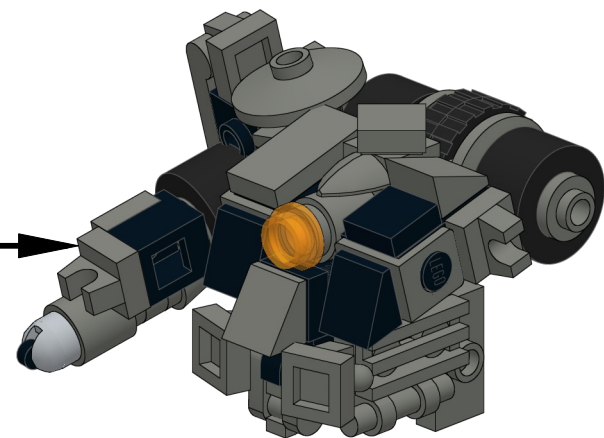
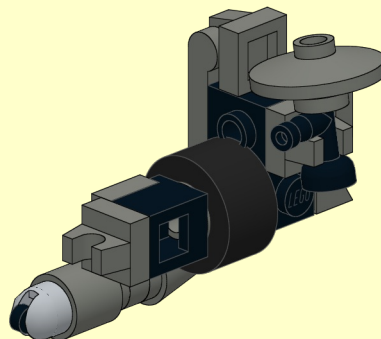
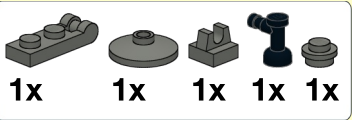

13

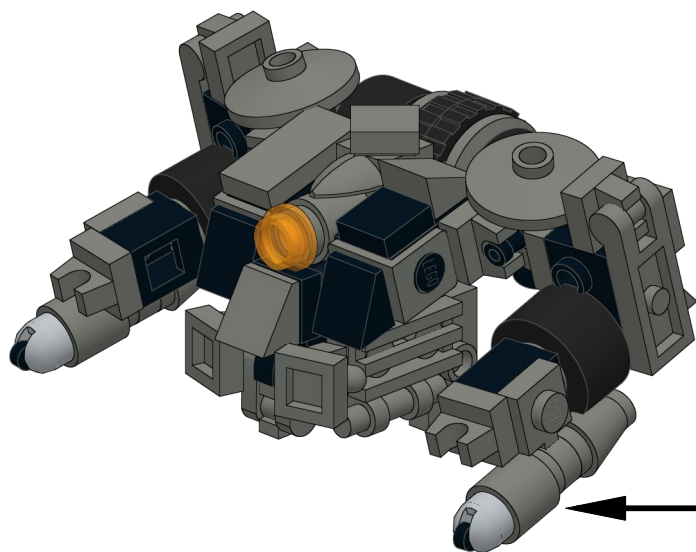
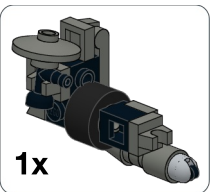

<p>1</p> <p>1x 1x</p>	<p>4</p> <p>1x 1x 1x</p>	<p>7</p> <p>1x 1x</p>
<p>2</p> <p>1x 1x 1x 1x</p>	<p>5</p> <p>1x 1x</p>	<p>8</p> <p>1x 1x 1x</p>
<p>3</p> <p>1x 1x</p>	<p>6</p> <p>1x 1x</p>	

- 1
- 1x
  - 1x
  - 1x

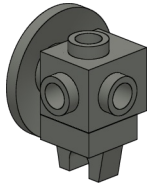

- 2
- 3x
  - 1x

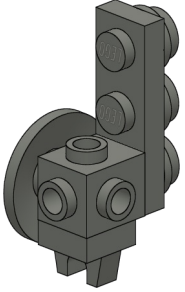

- 3
- 1x
  - 1x
  - 1x

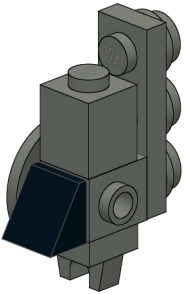

- 4
- 1x
  - 2x

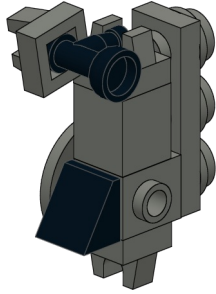

- 5
- 1x
  - 1x
  - 1x
  - 1x
  - 1x

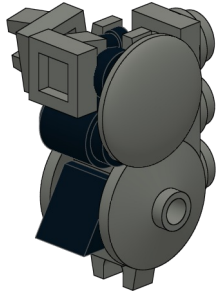

- 6
- 1x
  - 1x
  - 1x

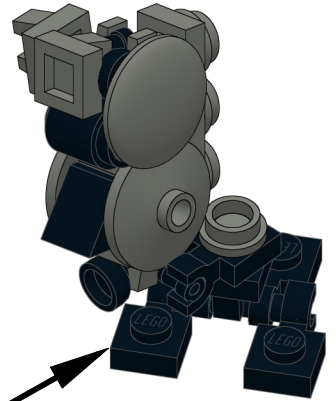

1

- 1x
- 1x

2

- 3x
- 1x

- 1
- 1x
  - 1x
  - 1x

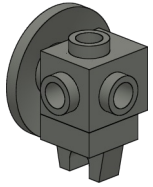

- 2
- 3x
  - 1x

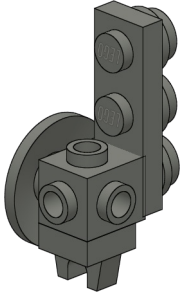

- 3
- 1x
  - 1x
  - 1x
  - 1x

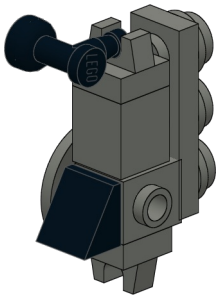

- 4
- 1x
  - 1x

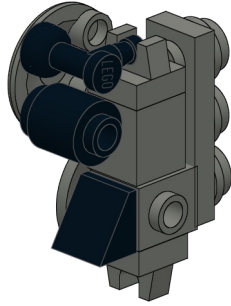

- 5
- 1x

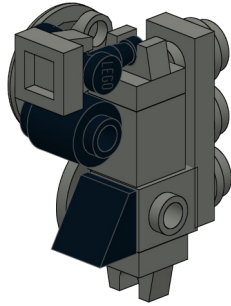

- 6
- 1x
  - 1x

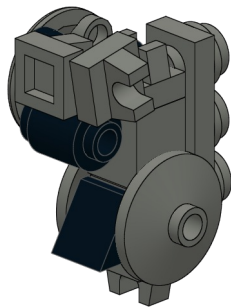

- 7
- 1x
  - 1x
  - 1x

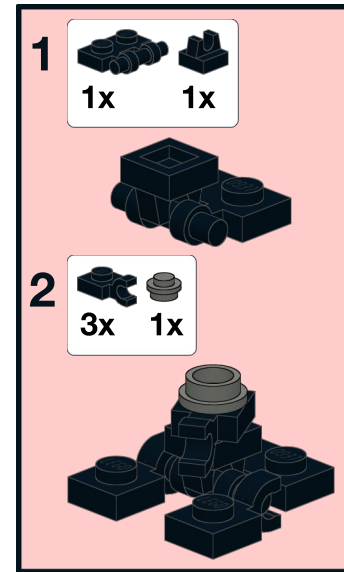
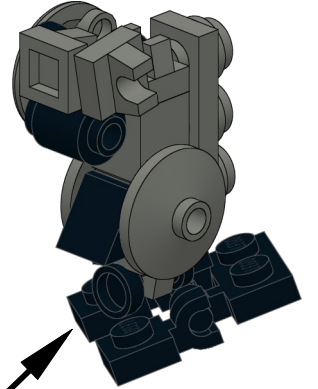

14

